

HSE ROHS

REV	ECN NO	DESCRIPTION	DATE	NAME
A		NEW		

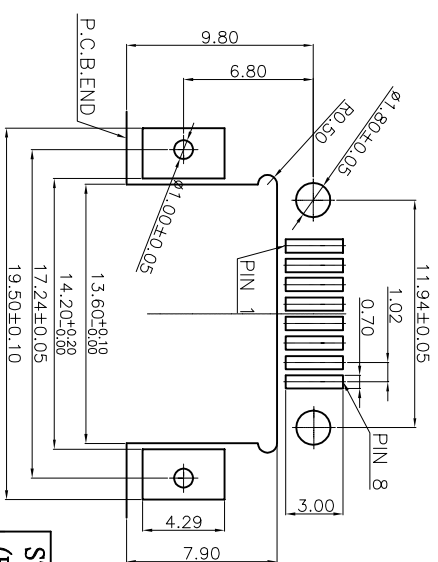
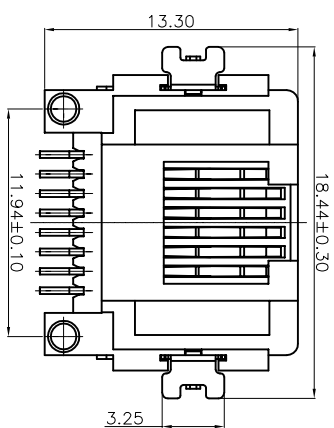
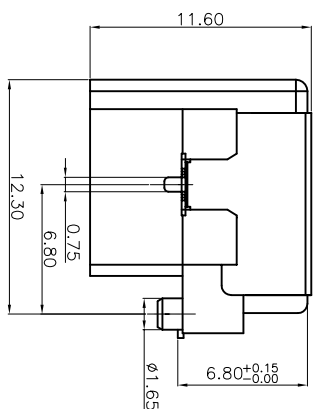
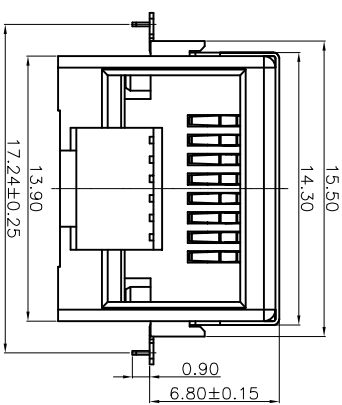
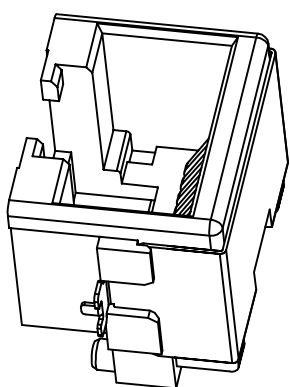
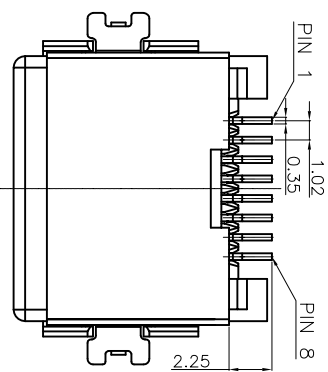

RECOMMEND P.C.B. Layout (T=1.20mm)
PCB TOLERANCE:±0.05

- NOTE:
- 1: MATERIAL:
 - <1> SHIELD: BRASS, T=0.2mm
 - <2> HOUSING: LCP, G/F FILLED, UL94V-0 RATED OR OTHER HIGH PERFORMANCE RESINS. COLOR IN BLACK.
 - <3> TERMINAL: PHOSPHOR BRONZE, T=0.30mm
 - 2: CONTACT PLATED: GOLD
 - 3: PCB TOLERANCES: DIMENSION ±0.05
 - 4: RETENTION FORCE OF PLUG IN THE JACK IS 10 kgf (min).
 - 5: SPECIFICATION:

DIELECTRIC STRENGTH: AC 500V FOR ONE MINUTE
INSULATION RESISTANCE: 100MΩ min. AT DC 100V
CONTACT RESISTANCE: 45mΩ max.
CURRENT RATING: 500mA
OPERATING TEMPERATURE: -30°C~+85°C

Ordering Information

L600XX - X X XX X

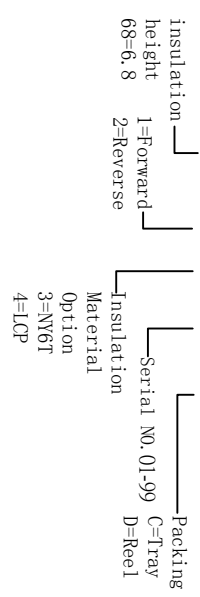

STANDARD TOLERANCE (EXCEPT SPECIFIED)	
LINER	ANGLES
0 ±0.30	0.° ±3°
.00 ±0.25	.0° ±2°
.000 ±0.15	.00° ±1°

LDCONN 东莞连大精密制品有限公司		DongGuan LianDa Precision Products Co., LTD	
R745 8P8C Sinking board type H6.8 SWF Forward		DRAWN BY	LuJunhui
TITLE		CHECKED BY	
PART NO	L60068-1401C	APPROVED BY	
DRAWING NO			
SCALE	1:1	UNIT	mm
		PAGE	1/1
		SIZE	A4