

HSE ROHS

REV	ECN NO	DESCRIPTION	DATE	NAME
A		NEW		

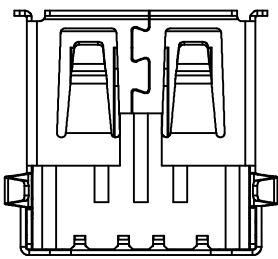
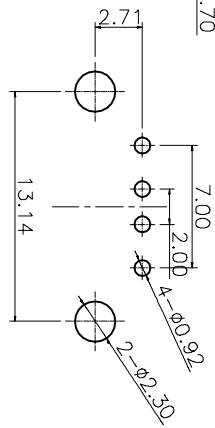
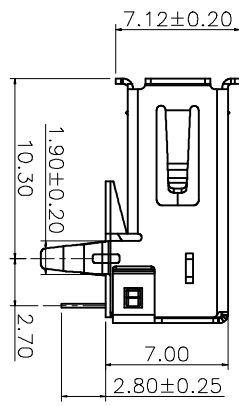
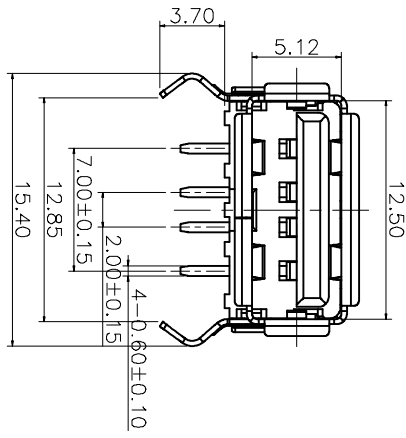
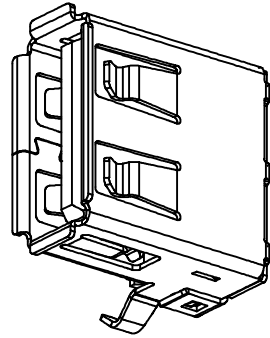
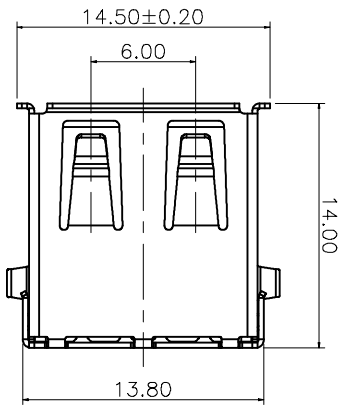

Recommend P.C.B LAYOUT

NOTE:

- Material:
 - Housing: PBT,UL94V-0; Color: White
 - Contact: C2680 T=0.2±0.03mm
 - Shell: SPCC T=0.3±0.03mm
- FINISH:
 - Contact: Au G/F Plated on Contact Area, Tin 80U" Plated on Solder Tails, Nickel 50U" Underplating Over All.
 - Shell: Nickel 80U" Underplating Over All.
- Specification:
 - 3.1: Electrical:
 - Contact Current Rating: 1.5A
 - Insulation Resistance: 1000MΩ Min.
 - Contact Resistance: 30 mΩ Max.
 - Dielectric Withstanding Voltage: 500V/AC 1Minute
 - 3.2 Mechanical:
 - Mating Force: 3.57Kgf Max.
 - Umating Force: 1.0Kgf Min.

Ordering Information

L75704 - 1 1 X XX X

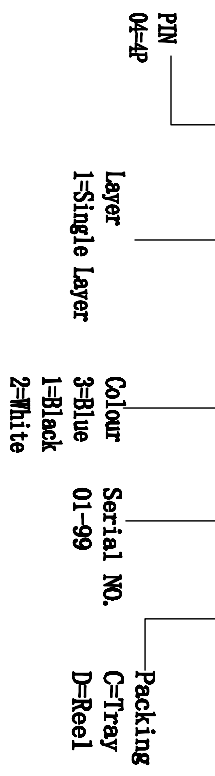

STANDARD TOLERANCE (EXCEPT SPECIFIED)	LINER	ANGLES
0 ±0.30	0.°	±3°
.00 ±0.20	.0°	±2°
.000 ±0.10	.00°	±1°

TITLE	PART NO	DRAWING NO	SCALE	UNIT	mm	PAGE	1/1	SIZE	A4
USB 2.0 A/F 90° L14.0	L75704-11XXXX		1:1						
<p>LDCONN 东莞连大精密制品有限公司 Dongguan LianDa Precision Products Co., LTD</p>									
DRAWN BY	CHECKED BY	APPROVED BY							
Lu Junhui									
18.11.08									